



MSZ-HC25VA

Classic Inverter Heat Pump

R410A Wall Mounted System

Mitsubishi Electric's new range of high specification, flat panel wall mounted models make use of inverter technology, whilst providing extremely good value for money, costing approximately 20% less than the MSZ-G equivalent. These units have extremely quiet sound levels, whilst also delivering economical air conditioning, with improved COP/EER figures.

- **Catechin Filter is optional**



Pictures not to scale

Product Details

MSZ-HC25VA Indoor Unit	
Capacity (kW):	
Heating (Nominal) (Low - High)	3.20 (0.90 - 4.40)
Cooling (Nominal) (Low - High)	2.50 (0.90 - 3.00)
Heating (UK) (Low - High)	2.65 (0.75 - 3.65)
Cooling (UK) (Low - High)	2.50 (0.90 - 3.00)
SHF R410A (Nominal)	0.79
COP / EER (Nominal)	3.64 / 3.25
Energy Label Heating / Cooling	A / A
Width - mm	788
Depth - mm	225
Height - mm	295
Weight - kg	9
Airflow (m ³ /min) (Heating /Cooling) - Lo-Mi-Hi-SupHi	5.1-6.5-7.8-9.1 / 5.3-7-8.7-10.5
Noise (dBA) (Heating/Cooling) - Lo-Mi-Hi-SupHi	26-32-38-43 / 26-32-38-43
Pipe Size Gas mm (in)	9.52 (3/8)
Pipe Size Liquid mm (in)	6.35 (1/4)
Electrical Supply	Fed by Outdoor Unit
Phase	Single
Fuse Rating (BS88) - HRC (A)	6
Interconnecting Cable No. Cores	4

MUZ-HC25VA Outdoor Unit	
Width - mm	684
Depth - mm	255
Height - mm	540
Weight - kg	25
Noise (dBA) (Heating /Cooling)	47 / 46
Electrical Supply	220-240v, 50Hz
Phase	Single
Fuse Rating (BS88) - HRC (A)	10
SystemPower Input (kW) - Heating (Nominal)	0.88
SystemPower Input (kW) - Cooling (Nominal)	0.77
SystemPower Input (kW) - Heating (UK)	0.801
SystemPower Input (kW) - Cooling (UK)	0.616
Starting Current (A)	4.2
SystemRunning Current (A) - Heating / Cooling	4.2 / 3.7
Mains Cable No. Cores	3
Max Pipe Length (m)	10
Max Height Difference (m)	5
Charge (kg) - 7m	0.73

Dimensions

MSZ-HC25VA

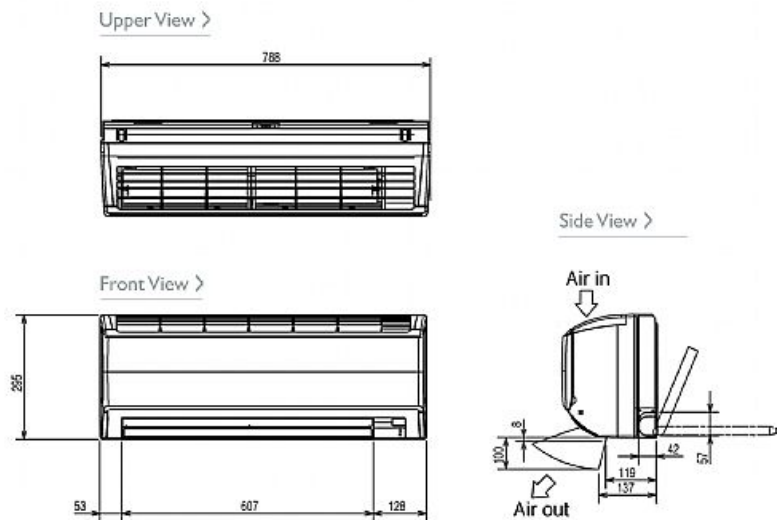

MSZ-HC25/35VA(B)

MUZ-HC25VA

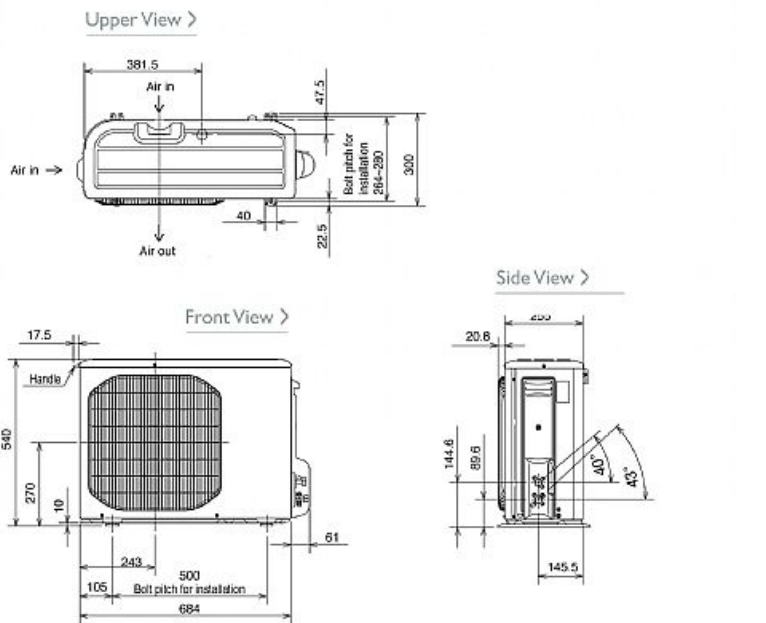

MUZ-HC25/35VA(B) / MUZ-GC25VA



Telephone: 01707 282880

Email: air.conditioning@meuk.mee.com Website: <http://www.mitsubishielectric.co.uk/aircon>

Tel:
Fax:



Mitsubishi Electric reserves the right to make any variation in technical specification to the equipment described, or to withdraw or replace products without prior notification or public announcement.